

CP5/CP8

Instruction book

583378

Multi Language - 10.2009



www.cooper-pegler.com

We congratulate you for choosing a Cooper Pegler plant protection product. The reliability and efficiency of this product depend upon your care. The first step is to carefully read and pay attention to this instruction book. It contains essential information for the efficient use and long life of this quality product.



Instructions



Instrucciones



Notice d'utilisation

Illustrations, technical information and data in this book are to the best of our belief correct at the time of printing. As it is EXEL GSA policy permanently to improve our products, we reserve the right to make changes in design, features, accessories, specifications and maintenance instructions at any time and without notice.

EXEL GSA is without any obligation in relation to implements purchased before or after such changes.

EXEL GSA cannot undertake any responsibility for possible omissions or inaccuracies in this publication, although everything possible has been done to make it complete and correct.

As this instruction book covers more models and features or equipment, which are available in certain countries only, please pay attention to paragraphs dealing with precisely your model.

Published and printed by EXEL GSA



Assembly . Montaje . Montage . Montering

Vigtig! Important! Wichtig! Importante!

DK Ved montage og 2 gange om året.

GB At assembly then twice a year.

F A l'assemblage, puis deux fois par an.

D Bei Montierung und zweimal jährlich.

E Al montar y dos veces al año.

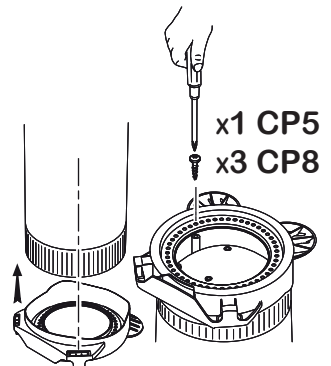
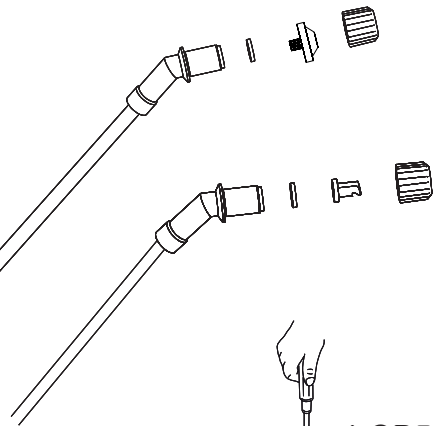
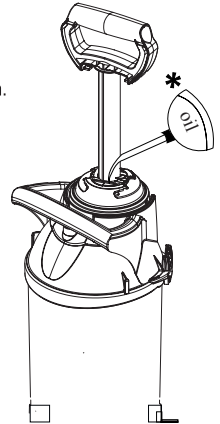
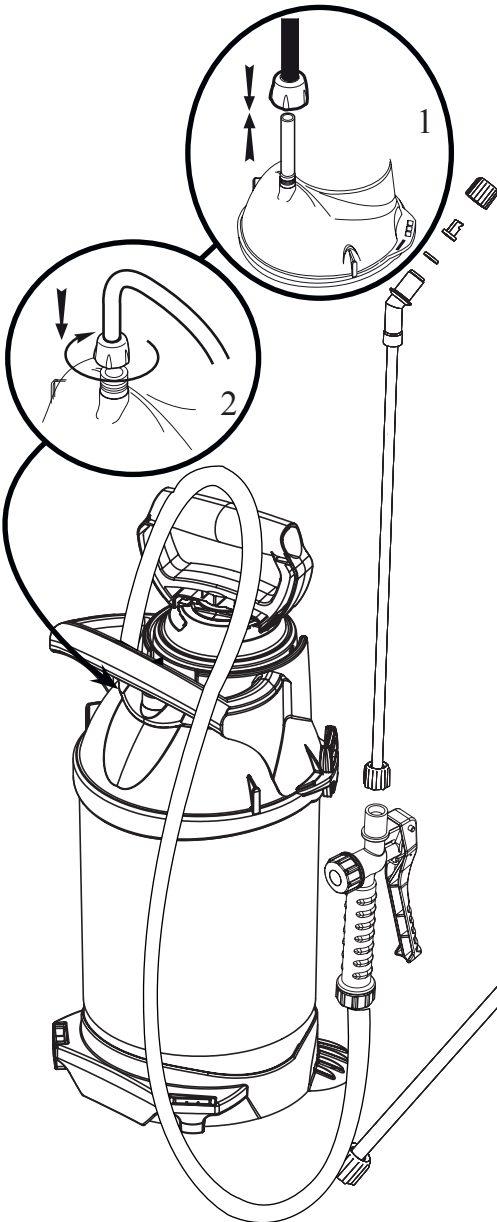

Operation . Funcionamiento . Wirken . Fonctionnement . Funktion



0 bar / PSI

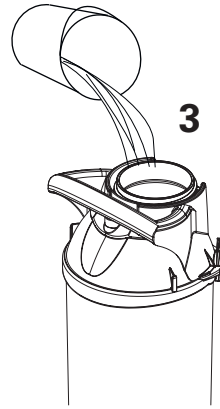
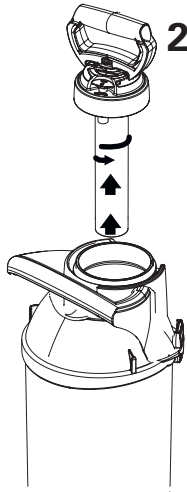

CP5 : 5l/1.10 imp.gal. /1.33 US gal
CP 8 : 8l/1.76 imp.gal. /2.11 US gal

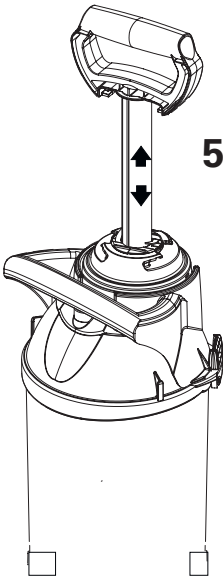
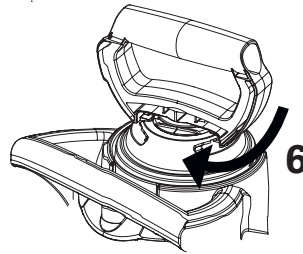
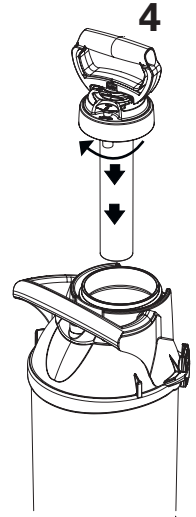

3 bar/ 45 PSI max

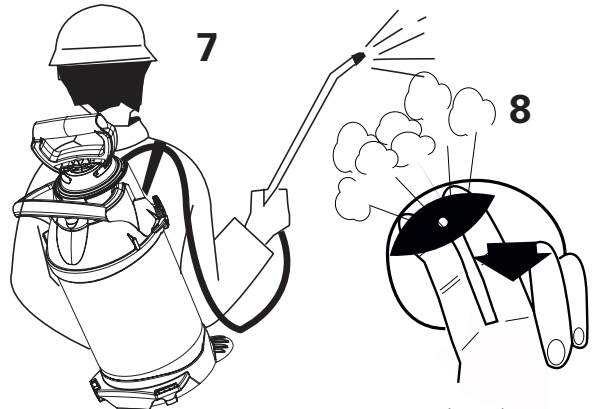

0 bar / PSI



Safety . Seguridad . Sicherheit . Sécurité . Sikkerhed

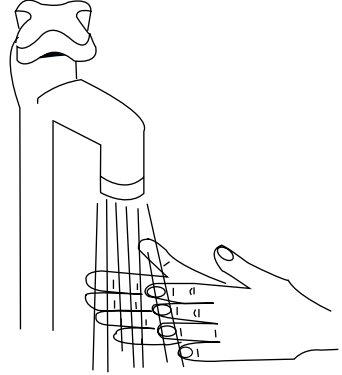
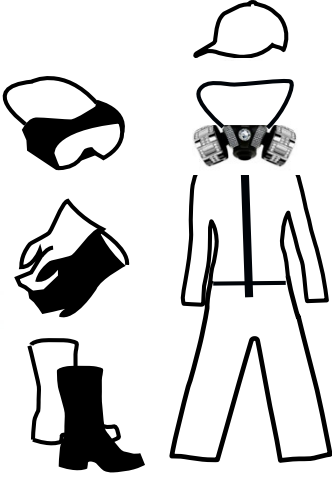
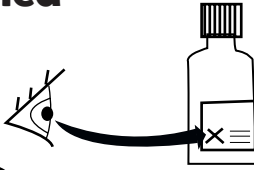

YES

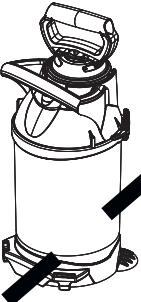
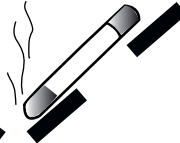
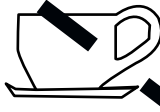

NO

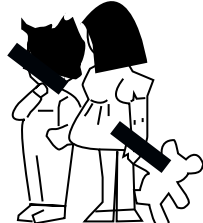

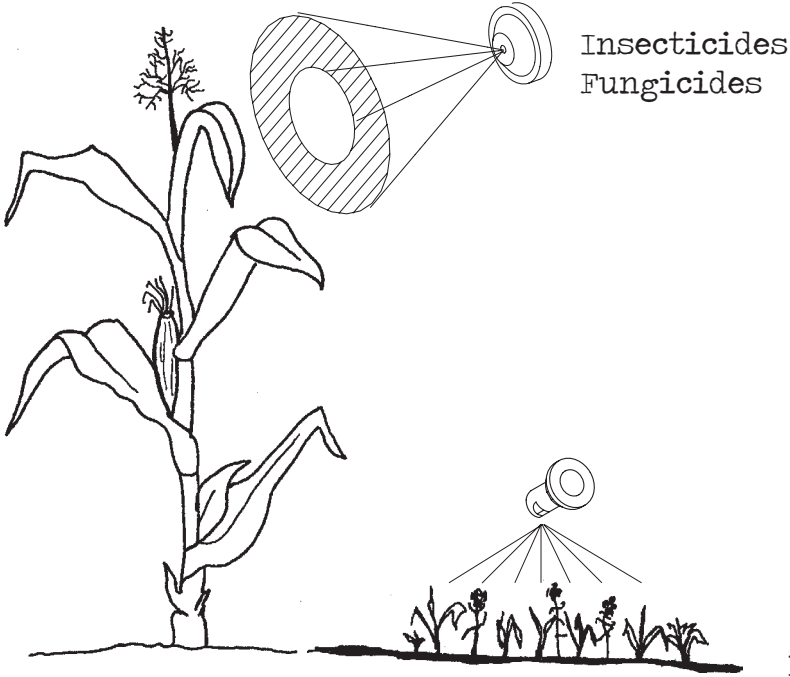
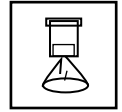

Nozzle choice . Selección de boquillas . Düsenwahl . Choix des buses . Dysevalg



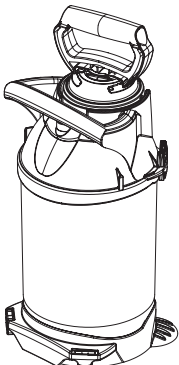
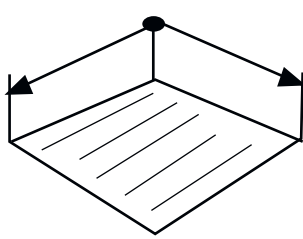

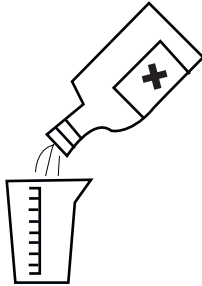
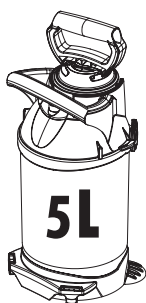

				
litre	Imp. gal	US gal.	m ²	yds
5	1.10	1.33	250	300
8	1.76	2.11	400	480

 <p>milli- litre/gram</p> <p>1 litre</p>		millilitre/gram TOTAL	
	%	 <p>5L</p>	 <p>8L</p>
1.0	0.1	5.0	8
1.5	0.15	7.5	12
2.0	0.2	10.0	16
2.5	0.25	12.5	20
3.0	0.3	15.0	24

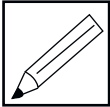
Opération . Funcionamiento . Wirken . Fonctionnement . Funktion



	ml g oz /		m ² sq.yds
weedexo	10ml/5 litres	372021	125m ²



Cleaning . Limpieza . Reinigung . Nettoyage . Rengøring

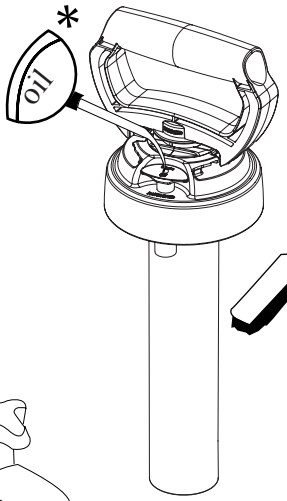

* Twice a year.
 Deux fois par an.
 Zweimal jährlich.
 Dos veces al año.
 To Gange om året

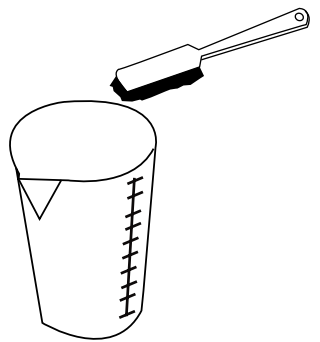
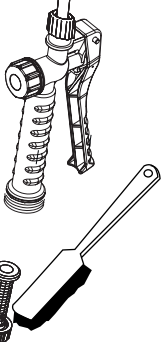
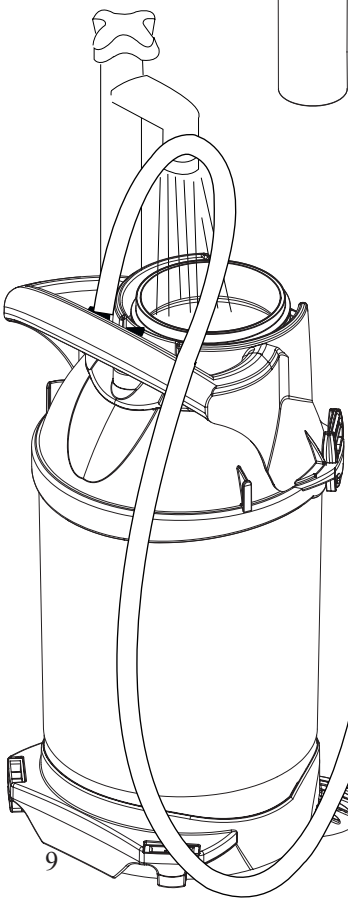
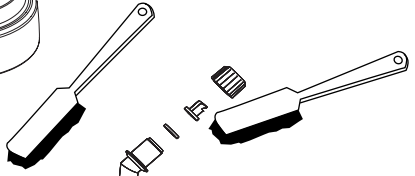

Specifications . Especificaciones . Spezifikation . Spécifications . Spezifikationer

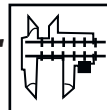

	kg	lb	litre	Imp.Gal.	US. gal
CP 5	1,55	3.4	5	1.10	1.33
CP 8	2.28	5	8	1.76	2.11

	MAXIMUM
	3 BAR / 45 PSI
	25 ° C / 77° F

		1 bar / 15 psi
	Green, Verde, Vert, Grün, Grøn 372021	1.2 l/m
		3 bar / 45 psi
	Yellow, Jaune, Gelb, Amarillo, Gul 371694	0.83 l/min

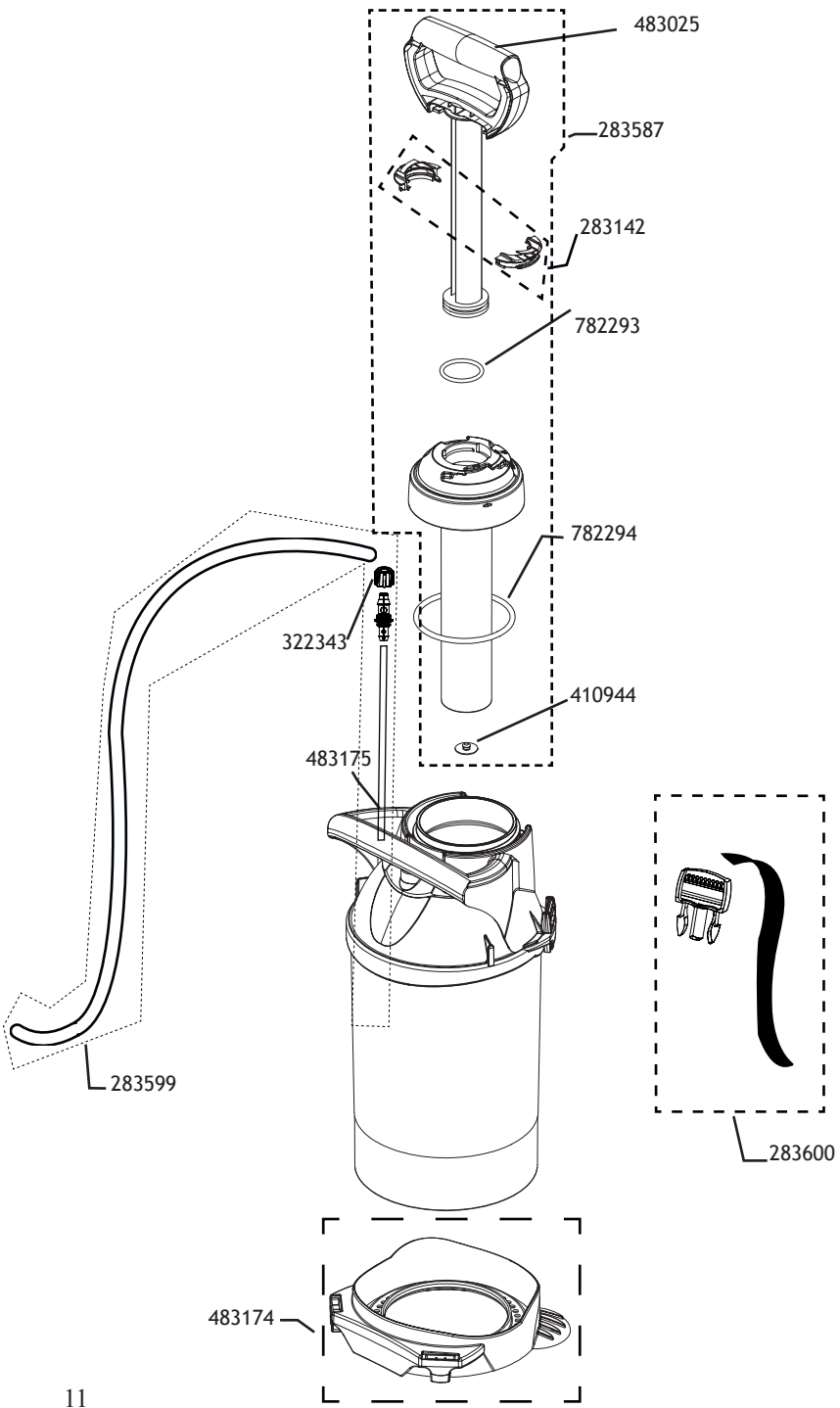

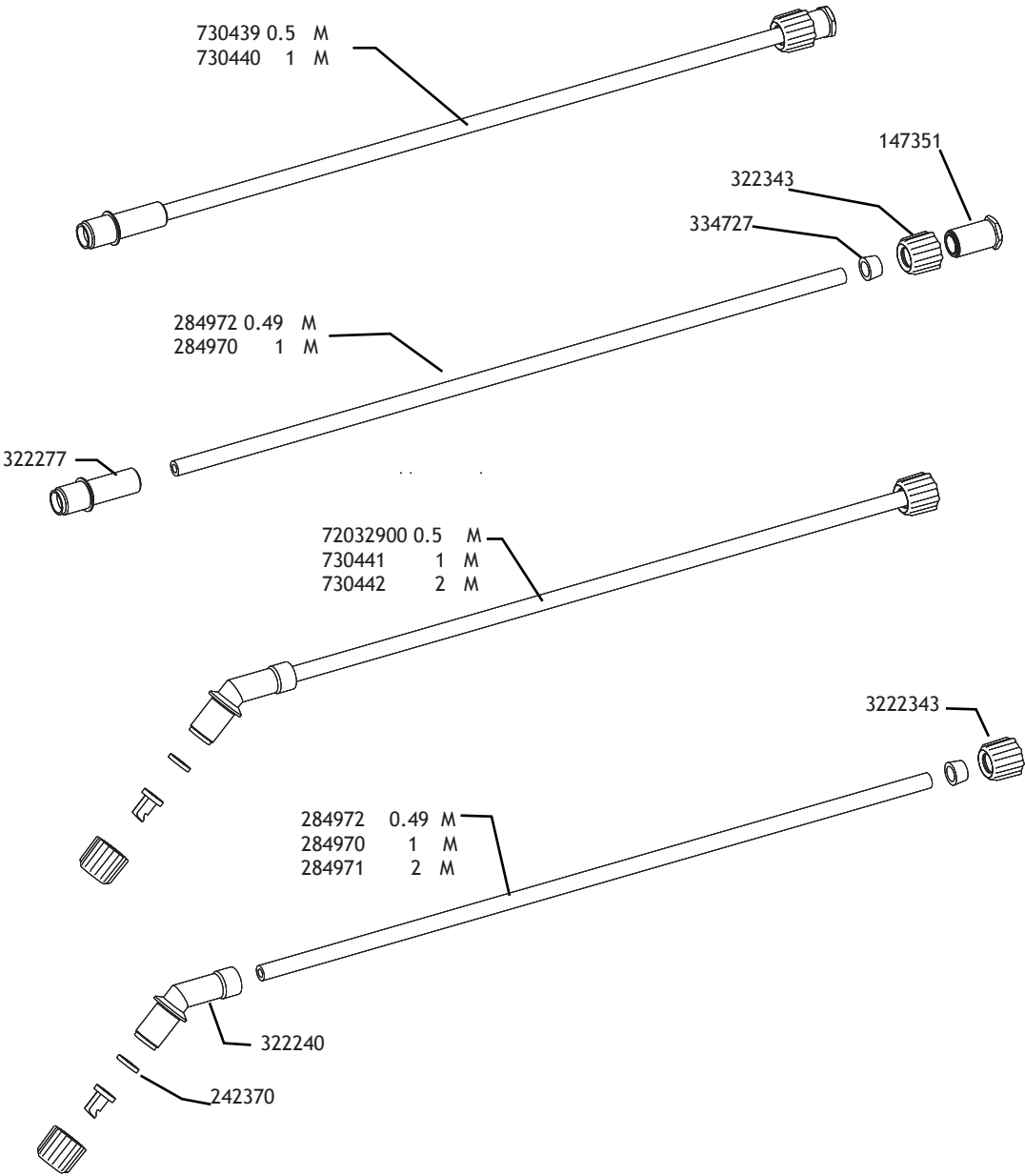

lances

20.02.09

